

Duży Format

60x120 / 30x120 / 20x120



NowaGala
CERAMIKA

MIRADOR gres szklwiony barwiony w masie	2
EBRO gres szklwiony barwiony w masie	10
VARIO gres barwiony w masie	22
NEUTRO gres barwiony w masie	38
CONCEPT gres barwiony w masie	50

MIRADOR

gres szklwiony barwiony w masie





PEI



R11
A+B+C



MR 01
59,7x119,7cm

R11
A+B+C



MR 01
59,7x59,7cm

R11
A+B+C

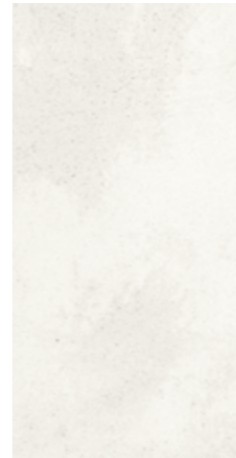

MR 01
29,7x59,7cm

R11
A+B+C



MR 13
59,7x119,7cm

R11
A+B+C



MR 13
59,7x59,7cm

R11
A+B+C



MR 13
29,7x59,7cm

R11
A+B+C



MR 12
59,7x119,7cm

R11
A+B+C

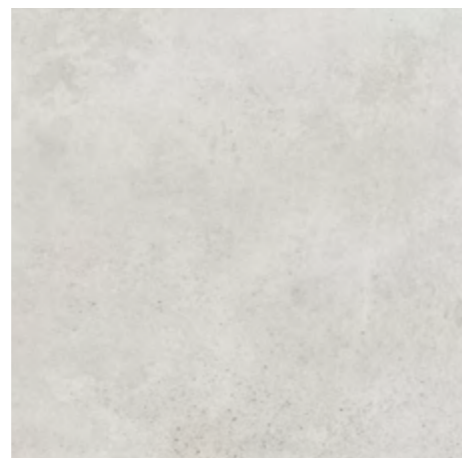

MR 12
59,7x59,7cm

R11
A+B+C

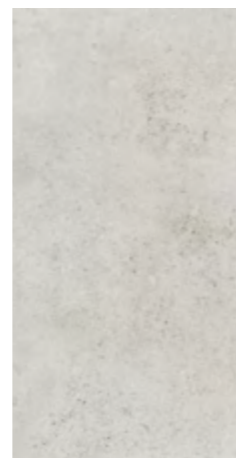

MR 12
29,7x59,7cm

R11
A+B+C

Płytki kolekcji Mirador cechuje różnorodność wzoru i tonalności.
Tile from Mirador collection are characterized by a wide variety of patterns and tonalities.
Fliesen der Mirador Kollektion zeichnet die Vielfalt von Mustern und Tonalitäten aus.
Плитки коллекции Mirador отличаются разнообразием рисунка и оттенка.

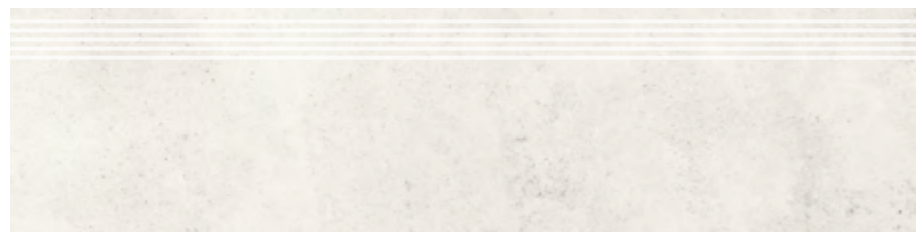

Stopnica **MR 01**
29,7x119,7cm

R11
A+B+C

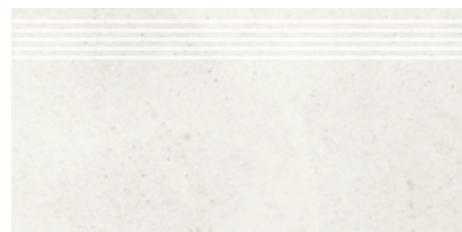

Stopnica **MR 01**
29,7x59,7cm

R11
A+B+C

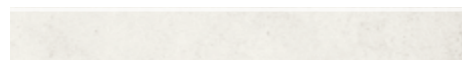

Cokół **MR 01**
7,8x59,7cm

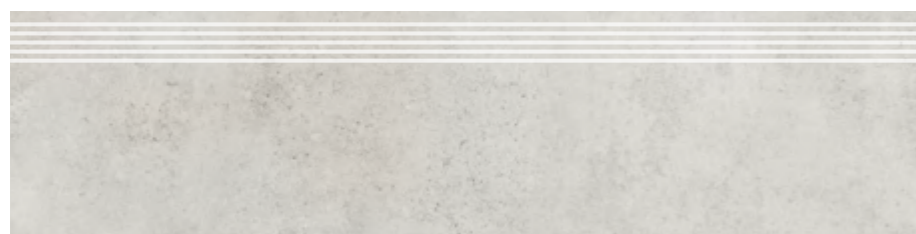

Stopnica **MR 12**
29,7x119,7cm

R11
A+B+C

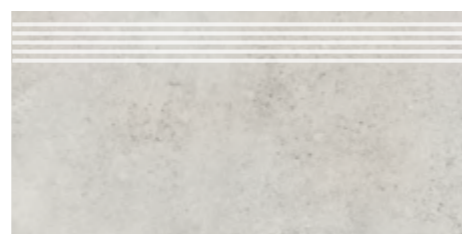

Stopnica **MR 12**
29,7x59,7cm

R11
A+B+C



Cokół **MR 12**
7,8x59,7cm

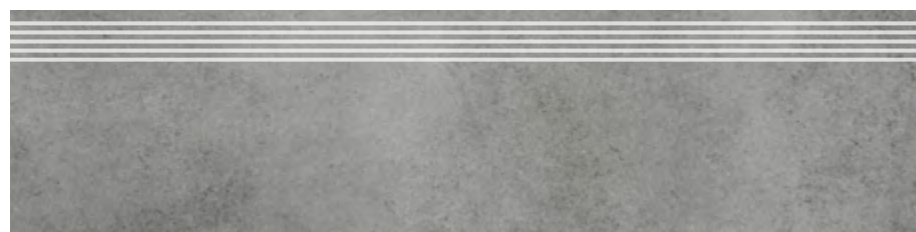

Stopnica **MR 13**
29,7x119,7cm

R11
A+B+C



Stopnica **MR 13**
29,7x59,7cm

R11
A+B+C



Cokół **MR 13**
7,8x59,7cm

MIRADOR



EBRO

gres szkliony barwiony w masie



EBRO

EB01 59,7x119,7 / 59,7x59,7 / 29,7x59,7

natura



EBRO



PEI



R10
A



EB 01
59,7x119,7cm **R10**
A

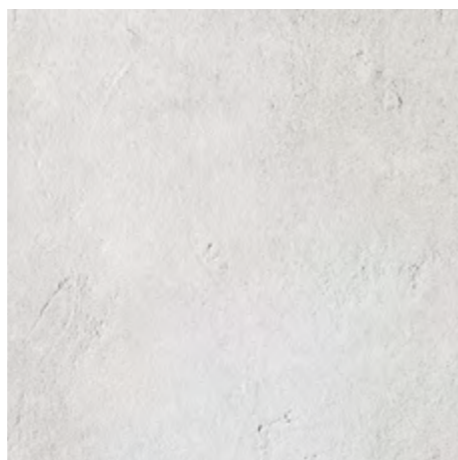

EB 01
59,7x59,7cm **R10**
A

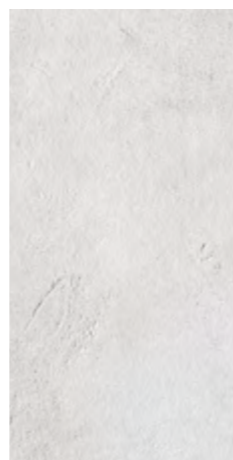

EB 01
29,7x59,7cm **R10**
A

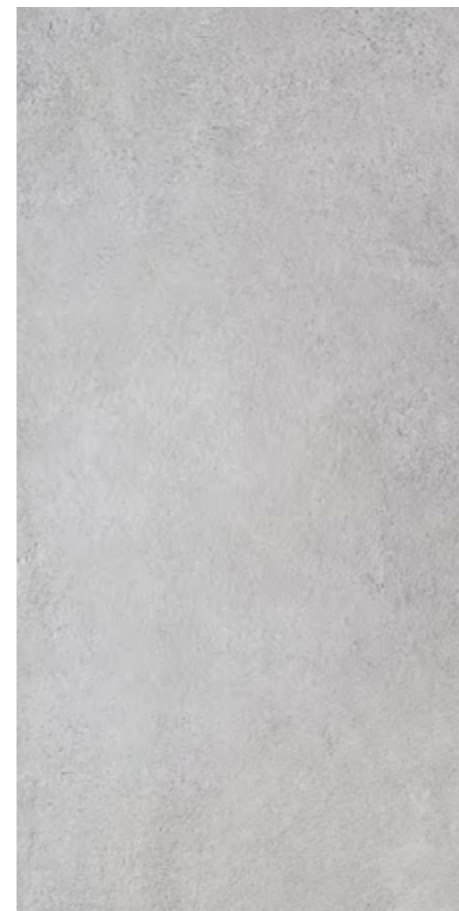

EB 12
59,7x119,7cm **R10**
A

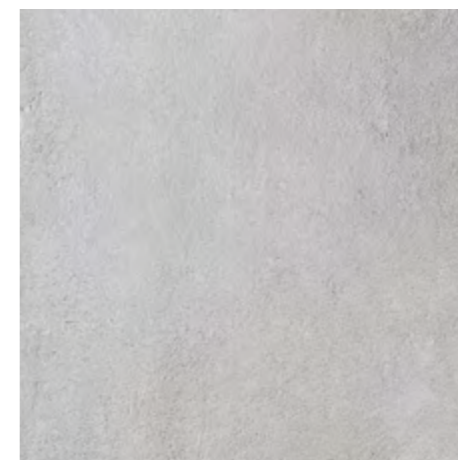

EB 12
59,7x59,7cm **R10**
A

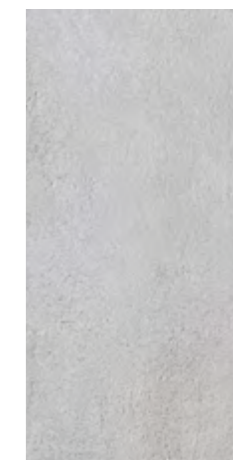

EB 12
29,7x59,7cm **R10**
A

Płytki kolekcji Ebro cechuje różnorodność wzoru i tonalności.
Tile from Ebro collection are characterized by a wide variety of patterns and tonalities.
Fliesen der Ebro Kollektion zeichnet die Vielfalt von Mustern und Tonalitäten aus.
Плитки коллекции Ebro отличаются разнообразием рисунка и оттенка.

EBRO



EB 03
59,7x119,7cm **R10**
A



EB 03
59,7x59,7cm **R10**
A

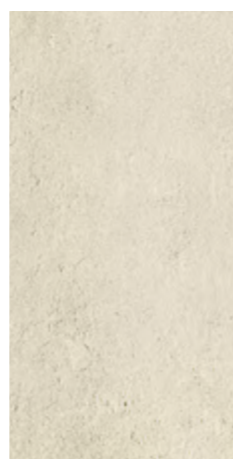

EB 03
29,7x59,7cm **R10**
A



EB 13
59,7x119,7cm **R10**
A



EB 13
59,7x59,7cm **R10**
A



EB 13
29,7x59,7cm **R10**
A



L-LCI-EB 01
53x61,3cm **R10**
A



L-LCI-EB 03
53x61,3cm **R10**
A



L-LCI-EB 12
53x61,3cm **R10**
A

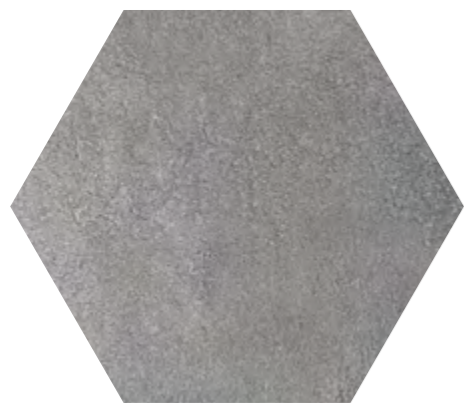

L-LCI-EB 13
53x61,3cm **R10**
A

EBRO





L-LDK-EB 01
59,7x59,7cm

R10
A



L-LDK-EB 03
59,7x59,7cm

R10
A



L-LDK-EB 12
59,7x59,7cm

R10
A

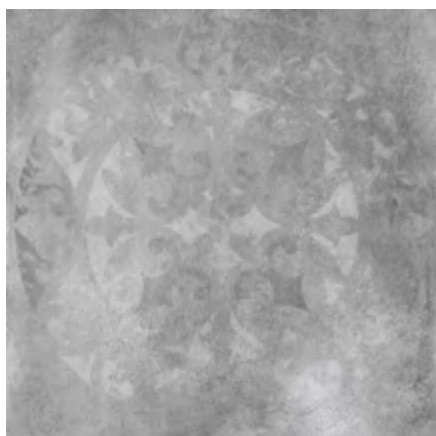

L-LDK-EB 13
59,7x59,7cm

R10
A



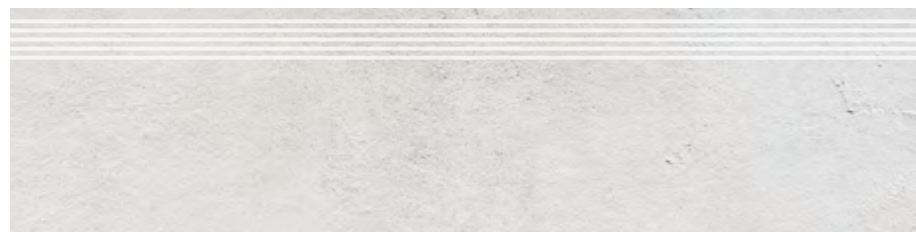

Stopnica **EB 01**
29,7x119,7cm

R10
A

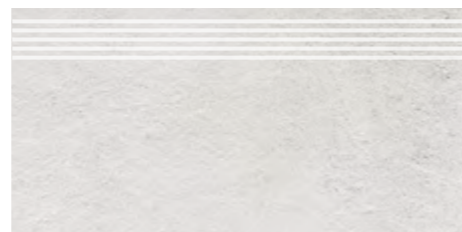

Stopnica **EB 01**
29,7x59,7cm

R10
A



Cokół **EB 01**
7,8x59,7cm

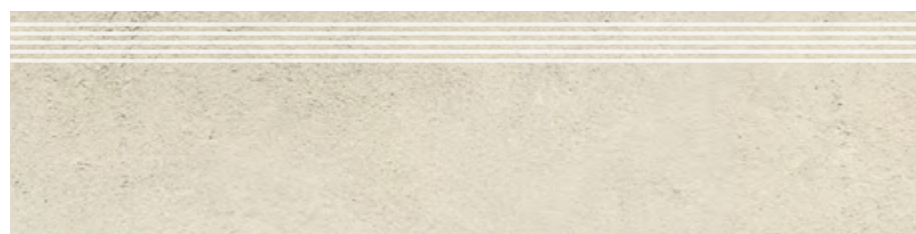

Stopnica **EB 03**
29,7x119,7cm

R10
A

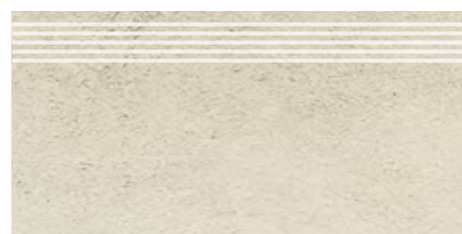

Stopnica **EB 03**
29,7x59,7cm

R10
A



Cokół **EB 03**
7,8x59,7cm

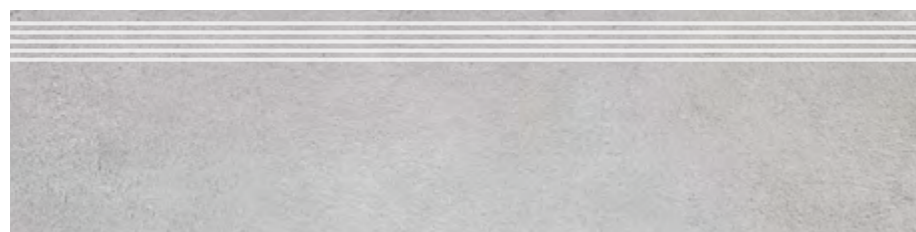

Stopnica **EB 12**
29,7x119,7cm

R10
A

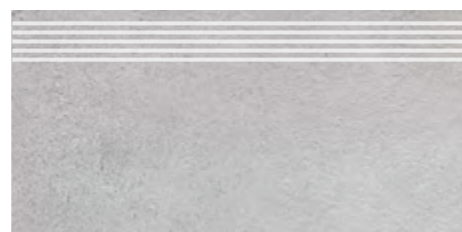

Stopnica **EB 12**
29,7x59,7cm

R10
A



Cokół **EB 12**
7,8x59,7cm

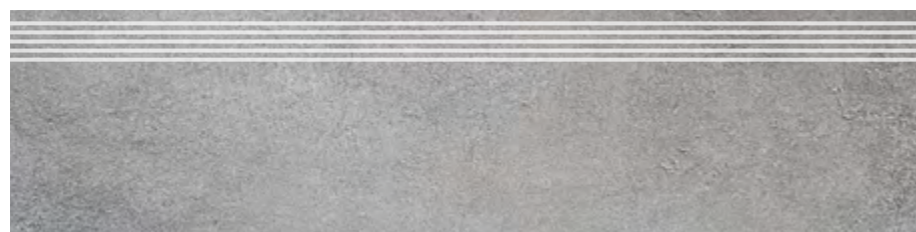

Stopnica **EB 13**
29,7x119,7cm

R10
A

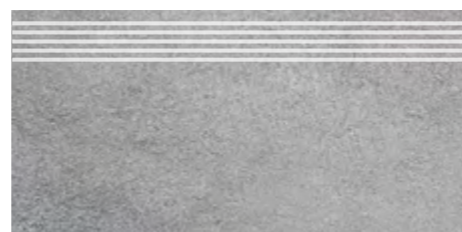

Stopnica **EB 13**
29,7x59,7cm

R10
A



Cokół **EB 13**
7,8x59,7cm



VARIO

gres barwiony w masie

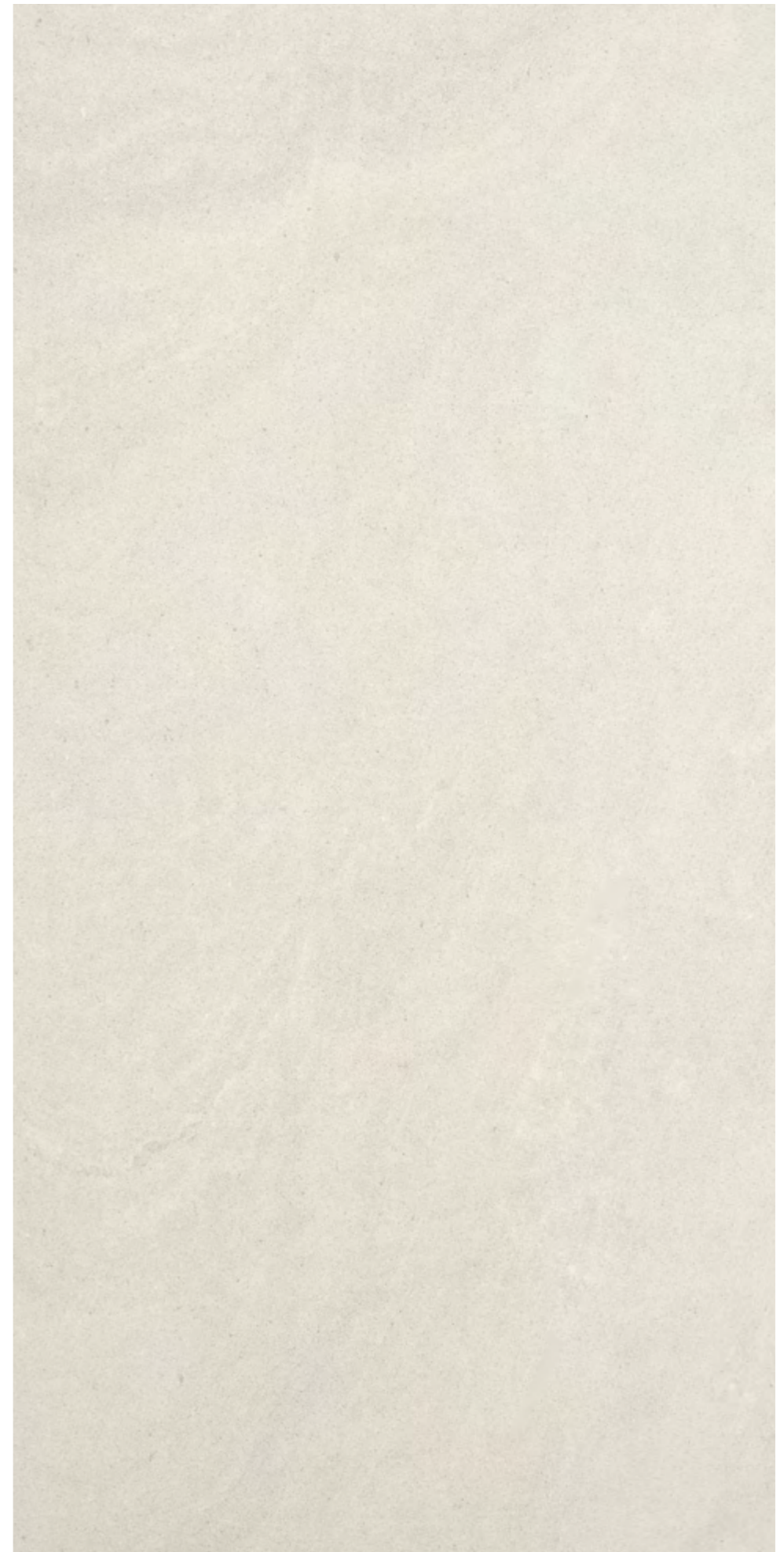

VARIO

VR01 59,7x119,7 / 29,7x119,7 / 19,3x119,7 / 59,7x59,7 / 29,7x59,7 natura/poler



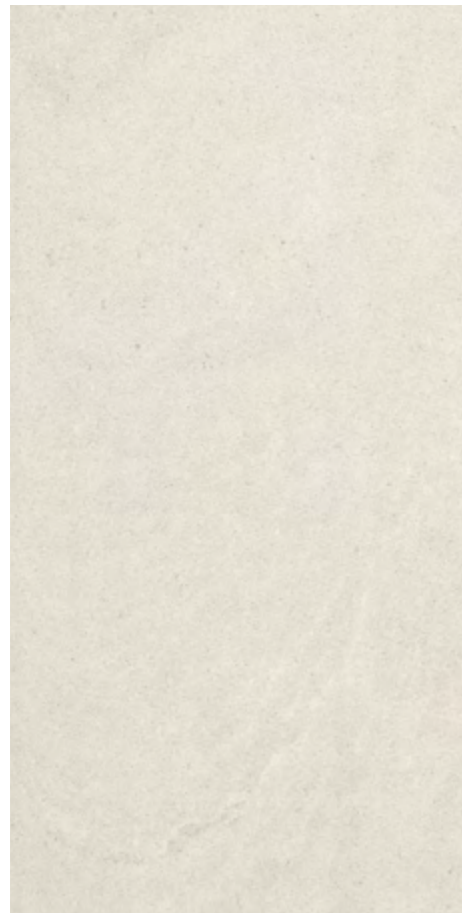

VR 01
59,7x119,7cm **R10**
A

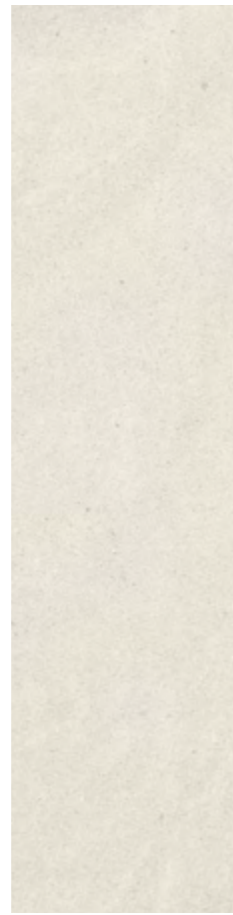

VR 01
29,7x119,7cm **R10**
A

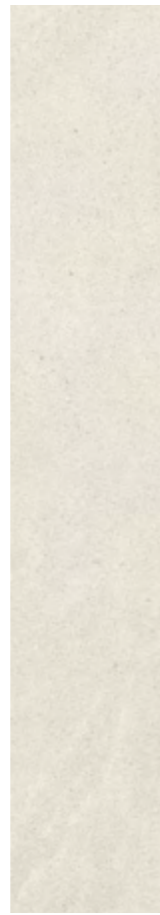

VR 01
19,3x119,7cm **R10**
A



VR 01
59,7x59,7cm **R10**
A



VR 01
29,7x59,7cm **R10**
A



VR 14
59,7x119,7cm **R10**
A



VR 14
29,7x119,7cm **R10**
A

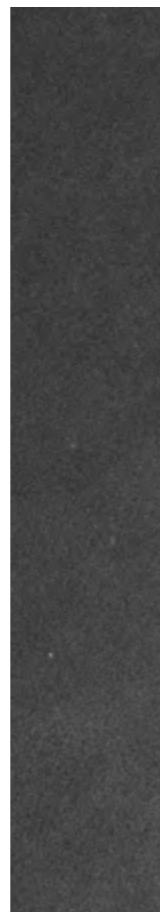

VR 14
19,3x119,7cm **R10**
A



VR 14
59,7x59,7cm **R10**
A

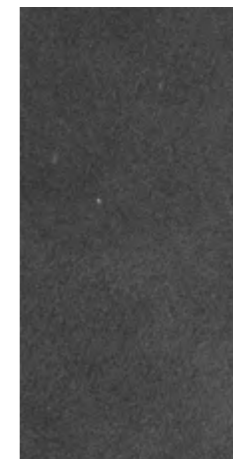

VR 14
29,7x59,7cm **R10**
A

Płytki kolekcji Vario cechuje różnorodność wzoru i tonalności.
Tile from Vario collection are characterized by a wide variety of patterns and tonalities.
Fliesen der Vario Kollektion zeichnet die Vielfalt von Mustern und Tonalitäten aus.
Плитки коллекции Vario отличаются разнообразием рисунка и оттенка.

VARIO



R10

A



VR 02
59,7x119,7cm

R10
A

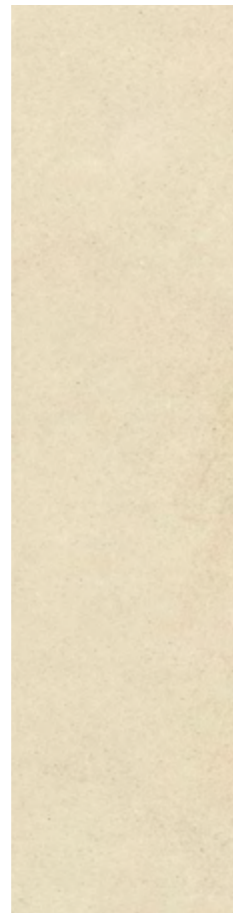

VR 02
29,7x119,7cm

R10
A

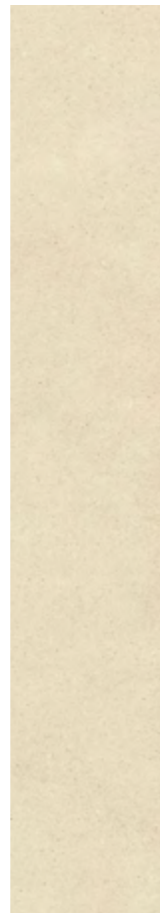

VR 02
19,3x119,7cm

R10
A



VR 02
59,7x59,7cm

R10
A

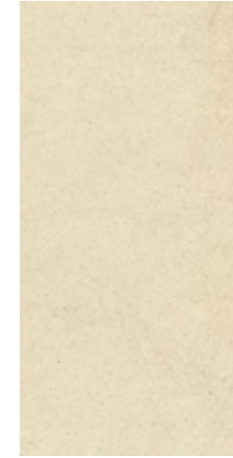

VR 02
29,7x59,7cm

R10
A



VR 04
59,7x119,7cm

R10
A



VR 04
29,7x119,7cm

R10
A



VR 04
19,3x119,7cm

R10
A



VR 04
59,7x59,7cm

R10
A



VR 04
29,7x59,7cm

R10
A

Płytki kolekcji Vario cechuje różnorodność wzoru i tonalności.
Tile from Vario collection are characterized by a wide variety of patterns and tonalities.
Fliesen der Vario Kollektion zeichnet die Vielfalt von Mustern und Tonalitäten aus.
Плитки коллекции Vario отличаются разнообразием рисунка и оттенка.



VR 12
59,7x119,7cm **R10**
A

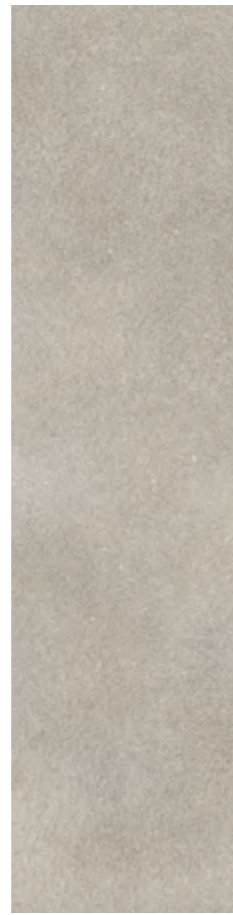

VR 12
29,7x119,7cm **R10**
A

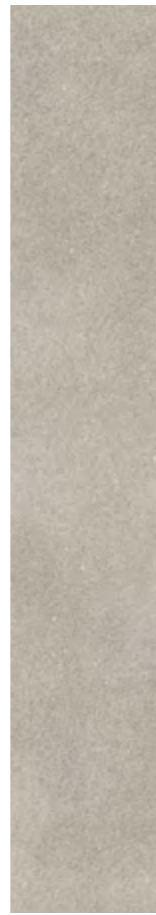

VR 12
19,3x119,7cm **R10**
A



VR 12
59,7x59,7cm **R10**
A

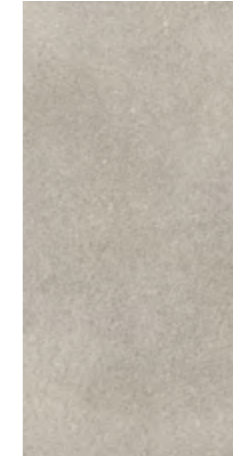

VR 12
29,7x59,7cm **R10**
A



VR 13
59,7x119,7cm **R10**
A

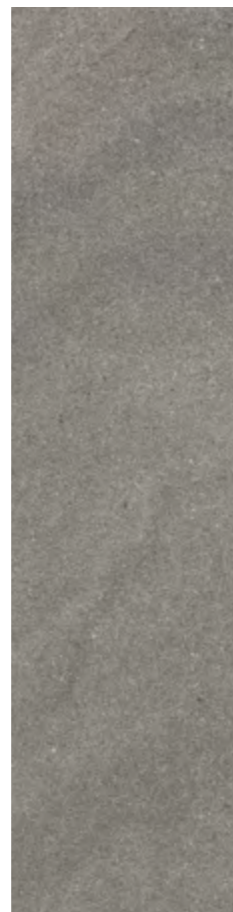

VR 13
29,7x119,7cm **R10**
A



VR 13
19,3x119,7cm **R10**
A



VR 13
59,7x59,7cm **R10**
A



VR 13
29,7x59,7cm **R10**
A

Płytki kolekcji Vario cechuje różnorodność wzoru i tonalności.
Tile from Vario collection are characterized by a wide variety of patterns and tonalities.
Fliesen der Vario Kollektion zeichnet die Vielfalt von Mustern und Tonalitäten aus.
Плитки коллекции Vario отличаются разнообразием рисунка и оттенка.



VR 10
59,7x119,7cm

R10
A

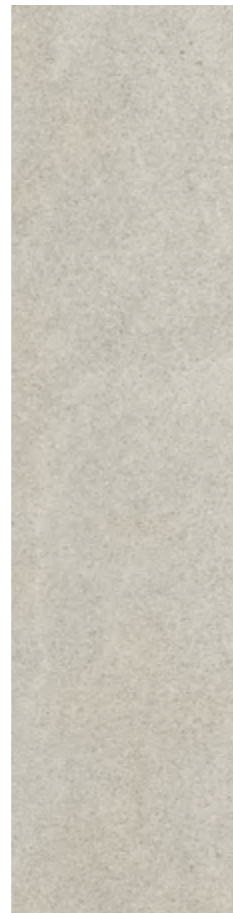

VR 10
29,7x119,7cm

R10
A

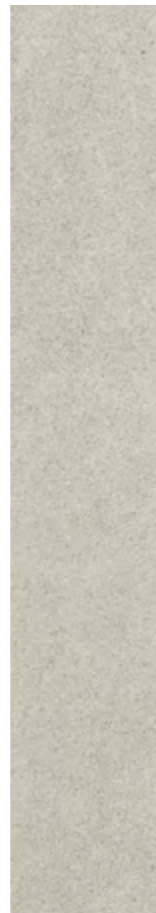

VR 10
19,3x119,7cm

R10
A



VR 10
59,7x59,7cm

R10
A

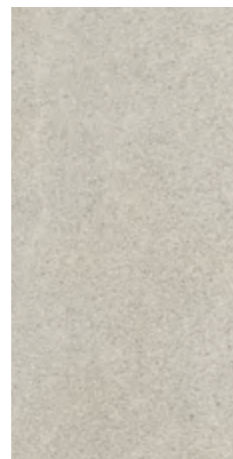

VR 10
29,7x59,7cm

R10
A

Płytki kolekcji Vario cechuje różnorodność wzoru i tonalności.
Tile from Vario collection are characterized by a wide variety of patterns and tonalities.
Fliesen der Vario Kollektion zeichnet die Vielfalt von Mustern und Tonalitäten aus.
Плитки коллекции Vario отличаются разнообразием рисунка и оттенка.

VARIO



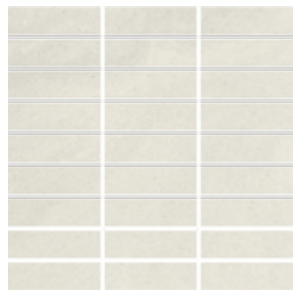

M-c-VR 01
29,7x29,7cm

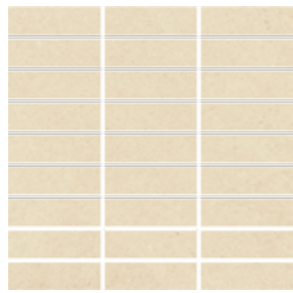

M-c-VR 02
29,7x29,7cm

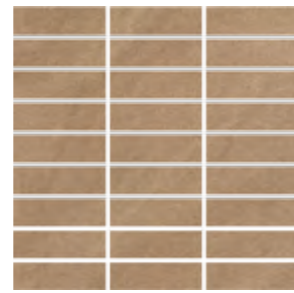

M-c-VR 04
29,7x29,7cm

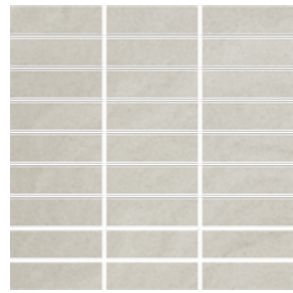

M-c-VR 10
29,7x29,7cm

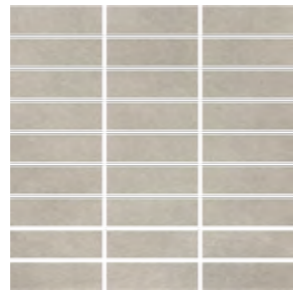

M-c-VR 12
29,7x29,7cm

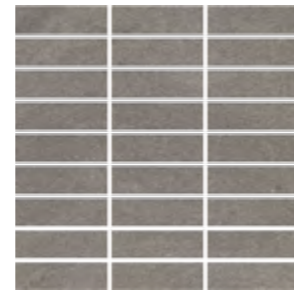

M-c-VR 13
29,7x29,7cm

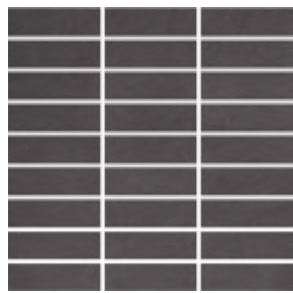

M-c-VR 14
29,7x29,7cm

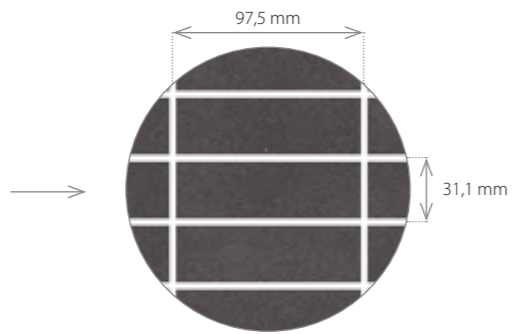

VARIO



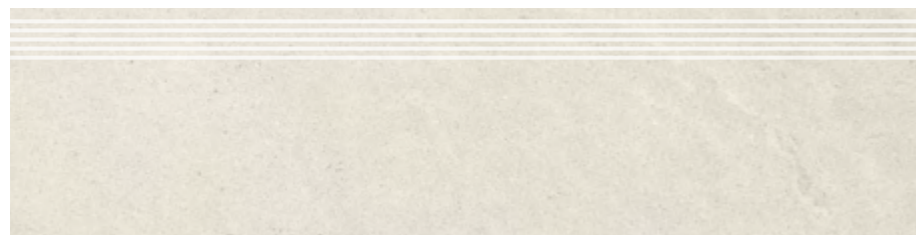

Stopnica **VR 01**
29,7x119,7cm

R10
A

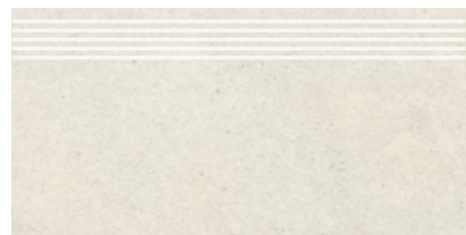

Stopnica **VR 01**
29,7x59,7cm

R10
A



Cokół **VR 01**
7,8x59,7cm

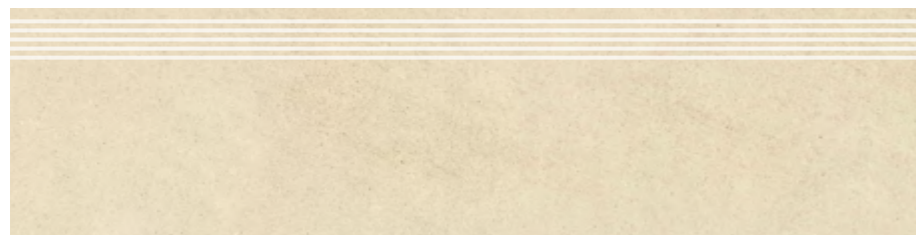

Stopnica **VR 02**
29,7x119,7cm

R10
A

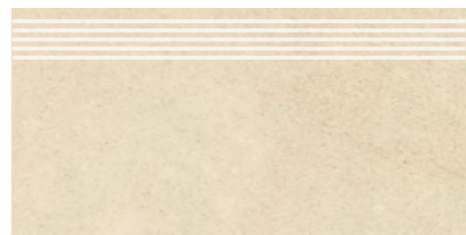

Stopnica **VR 02**
29,7x59,7cm

R10
A

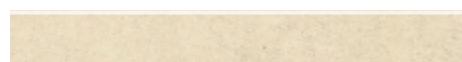

Cokół **VR 02**
7,8x59,7cm



Stopnica **VR 04**
29,7x119,7cm

R10
A



Stopnica **VR 04**
29,7x59,7cm

R10
A



Cokół **VR 04**
7,8x59,7cm

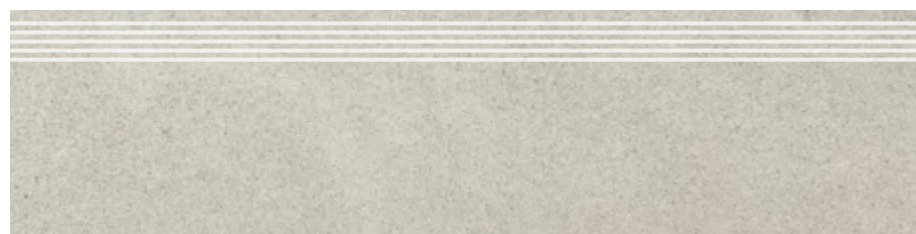

Stopnica **VR 10**
29,7x119,7cm

R10
A



Stopnica **VR 10**
29,7x59,7cm

R10
A



Cokół **VR 10**
7,8x59,7cm



Stopnica **VR 12**
29,7x119,7cm

R10
A

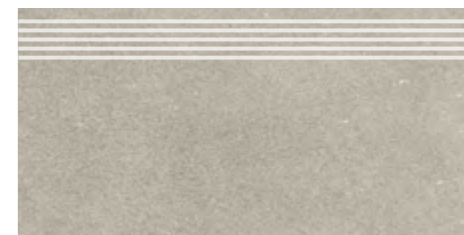

Stopnica **VR 12**
29,7x59,7cm

R10
A



Cokół **VR 12**
7,8x59,7cm



Stopnica **VR 13**
29,7x119,7cm

R10
A



Stopnica **VR 13**
29,7x59,7cm

R10
A



Cokół **VR 13**
7,8x59,7cm



Stopnica **VR 14**
29,7x119,7cm

R10
A



Stopnica **VR 14**
29,7x59,7cm

R10
A



Cokół **VR 14**
7,8x59,7cm

NEUTRO

gres barwiony w masie



NEUTRO

NU12 59,7x119,7 / 29,7x119,7 / 19,3x119,7 / 59,7x59,7 / 29,7x59,7

natura/poler



R10
A

NEUTRO





NU 01
59,7x119,7cm **R10**
A

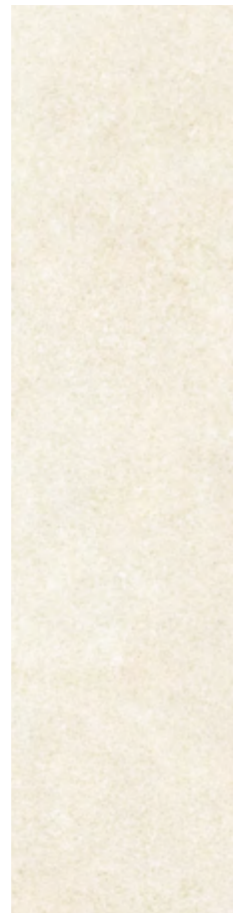

NU 01
29,7x119,7cm **R10**
A

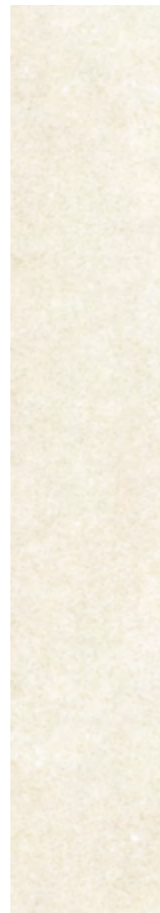

NU 01
19,3x119,7cm **R10**
A



NU 01
59,7x59,7cm **R10**
A

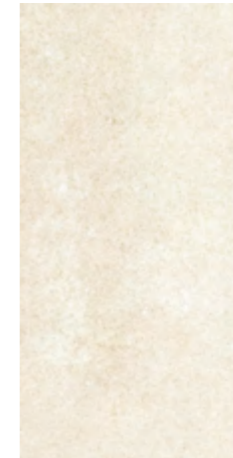

NU 01
29,7x59,7cm **R10**
A



NU 02
59,7x119,7cm **R10**
A

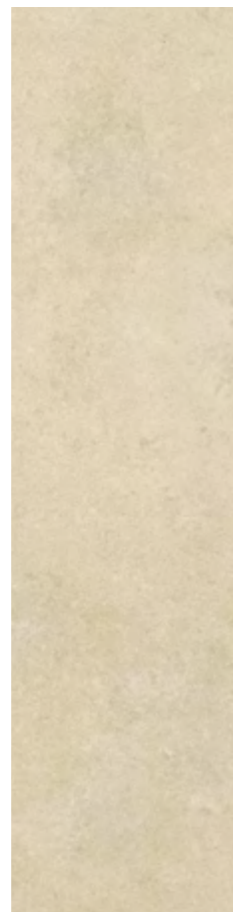

NU 02
29,7x119,7cm **R10**
A

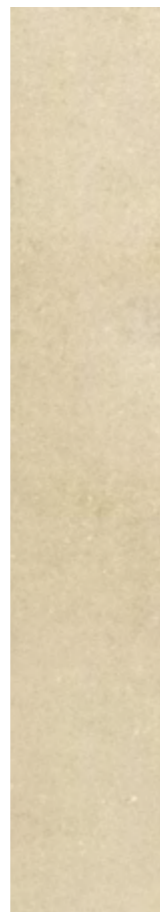

NU 02
19,3x119,7cm **R10**
A

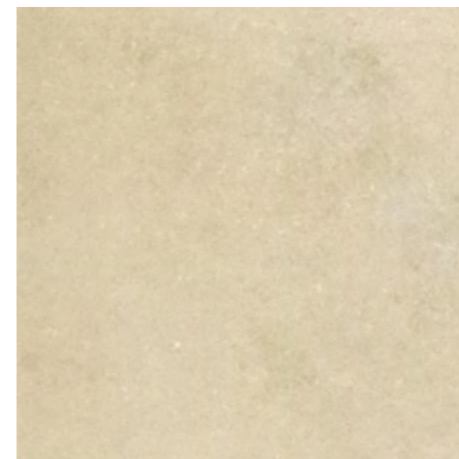

NU 02
59,7x59,7cm **R10**
A

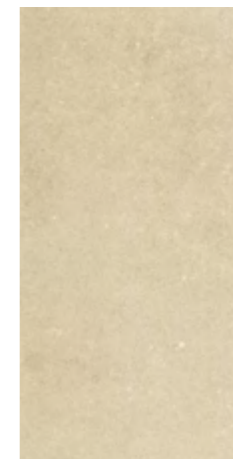

NU 02
29,7x59,7cm **R10**
A

Płytki kolekcji Neutro cechuje różnorodność wzoru i tonalności.
Tile from Neutro collection are characterized by a wide variety of patterns and tonalities.
Fliesen der Neutro Kollektion zeichnet die Vielfalt von Mustern und Tonalitäten aus.
Плитки коллекции Neutro отличаются разнообразием рисунка и оттенка.



NU 12
59,7x119,7cm

R10
A

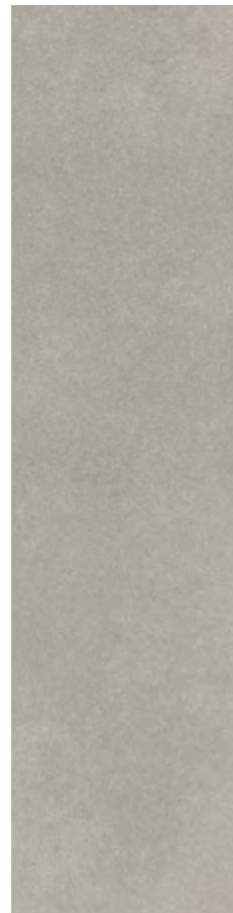

NU 12
29,7x119,7cm

R10
A

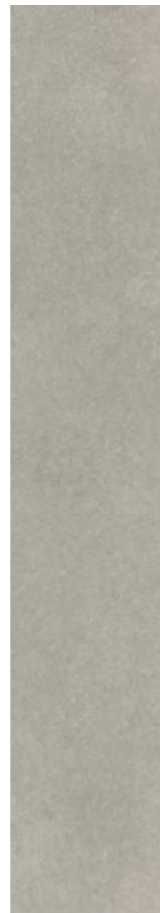

NU 12
19,3x119,7cm

R10
A



NU 12
59,7x59,7cm

R10
A



NU 12
29,7x59,7cm

R10
A



NU 13
59,7x119,7cm

R10
A

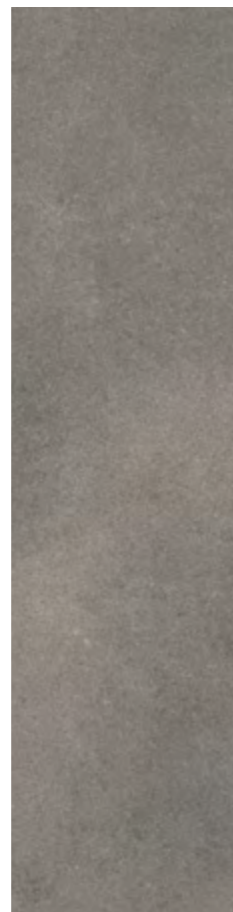

NU 13
29,7x119,7cm

R10
A

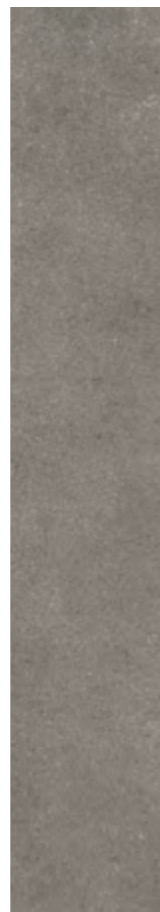

NU 13
19,3x119,7cm

R10
A



NU 13
59,7x59,7cm

R10
A



NU 13
29,7x59,7cm

R10
A

Płytki kolekcji Neutro cechuje różnorodność wzoru i tonalności.
Tile from Neutro collection are characterized by a wide variety of patterns and tonalities.
Fliesen der Neutro Kollektion zeichnet die Vielfalt von Mustern und Tonalitäten aus.
Плитки коллекции Neutro отличаются разнообразием рисунка и оттенка.

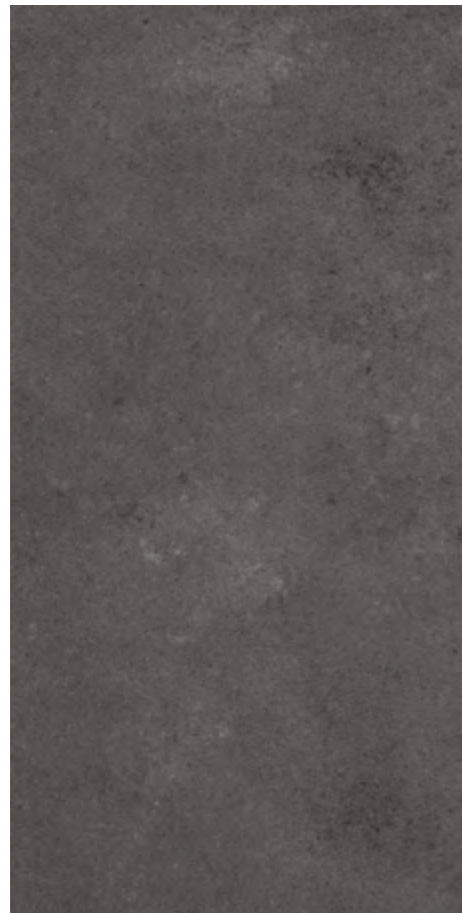

NU 14
59,7x119,7cm

R10
A



NU 14
29,7x119,7cm

R10
A



NU 14
19,3x119,7cm

R10
A

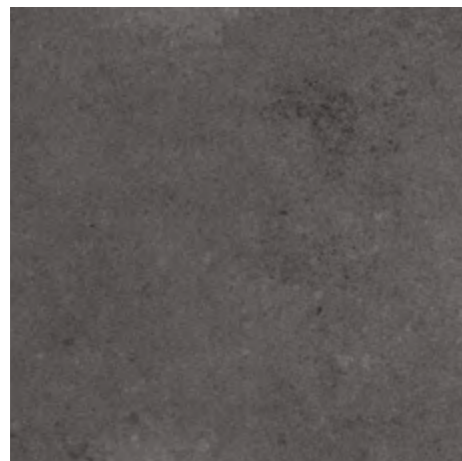

NU 14
59,7x59,7cm

R10
A



NU 14
29,7x59,7cm

R10
A

Płytki kolekcji Neutro cechuje różnorodność wzoru i tonalności.
Tile from Neutro collection are characterized by a wide variety of patterns and tonalities.
Fliesen der Neutro Kollektion zeichnet die Vielfalt von Mustern und Tonalitäten aus.
Плитки коллекции Neutro отличаются разнообразием рисунка и оттенка.



NEUTRO

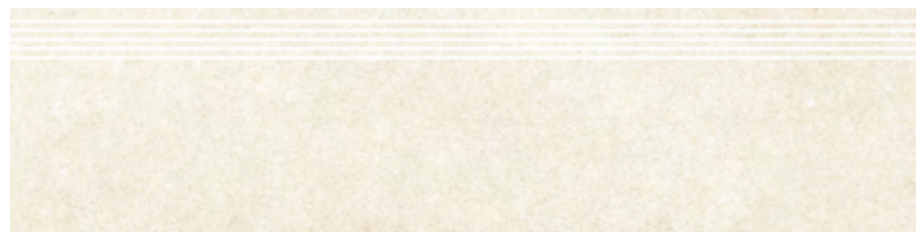

Stopnica **NU 01**
29,7x119,7cm

R10
A

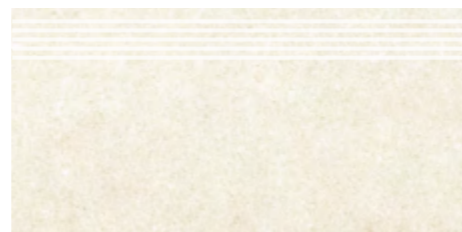

Stopnica **NU 01**
29,7x59,7cm

R10
A



Cokół **NU 01**
7,8x59,7cm

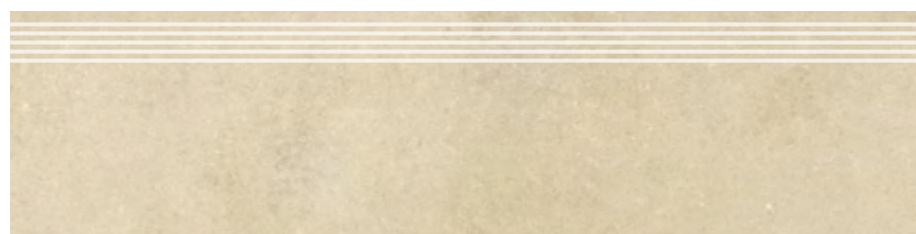

Stopnica **NU 02**
29,7x119,7cm

R10
A

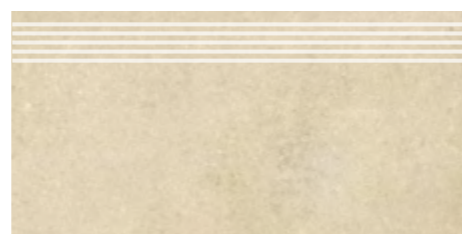

Stopnica **NU 02**
29,7x59,7cm

R10
A



Cokół **NU 02**
7,8x59,7cm

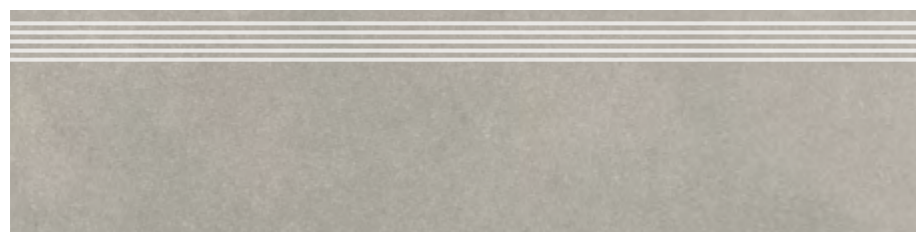

Stopnica **NU 12**
29,7x119,7cm

R10
A

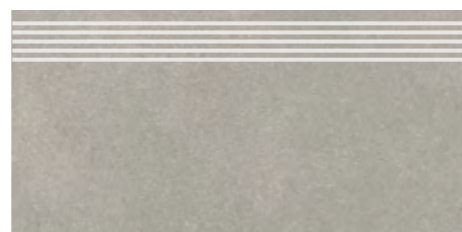

Stopnica **NU 12**
29,7x59,7cm

R10
A



Cokół **NU 12**
7,8x59,7cm



Stopnica **NU 13**
29,7x119,7cm

R10
A



Stopnica **NU 13**
29,7x59,7cm

R10
A



Cokół **NU 13**
7,8x59,7cm



Stopnica **NU 14**
29,7x119,7cm

R10
A



Stopnica **NU 14**
29,7x59,7cm

R10
A



Cokół **NU 14**
7,8x59,7cm

CONCEPT

gres barwiony w masie



CONCEPT

CN14 59,7x119,7 / 59,7x59,7 / 29,7x59,7 / 29,7x29,7

natura/poler



CONCEPT



R10
A



CN 99
59,7x119,7cm

R10
A



CN 99
59,7x59,7cm

R10
A

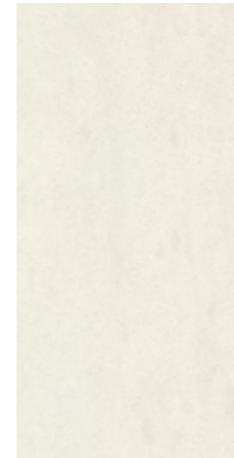

CN 99
29,7x59,7cm

R10
A

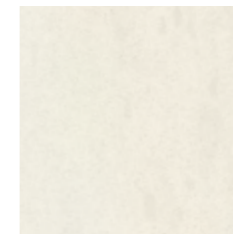

CN 99
29,7x29,7cm

R10
A

Płytki kolekcji Concept cechuje różnorodność wzoru i tonalności.
Tile from Concept collection are characterized by a wide variety of patterns and tonalities.
Fliesen der Concept Kollektion zeichnet die Vielfalt von Mustern und Tonalitäten aus.
Плитки коллекции Concept отличаются разнообразием рисунка и оттенка.

CONCEPT



CN 14
59,7x119,7cm

R10
A

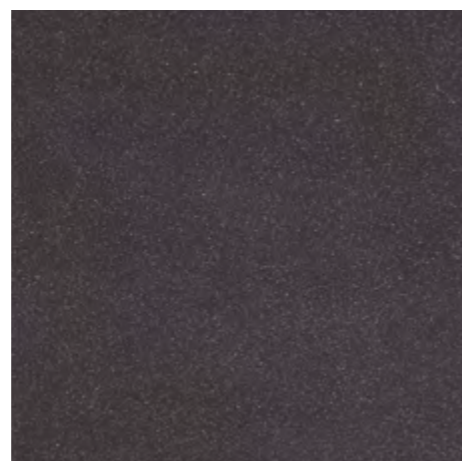

CN 14
59,7x59,7cm

R10
A

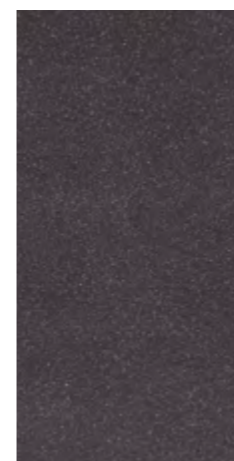

CN 14
29,7x59,7cm

R10
A

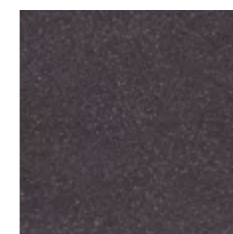

CN 14
29,7x29,7cm

R10
A



CN 12
59,7x119,7cm

R10
A



CN 12
59,7x59,7cm

R10
A

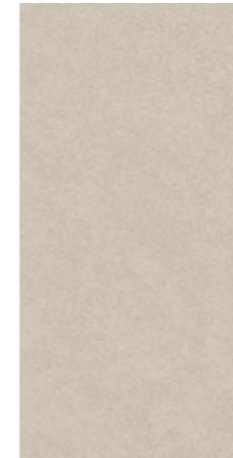

CN 12
29,7x59,7cm

R10
A



CN 12
29,7x29,7cm

R10
A

Płytki kolekcji Concept cechuje różnorodność wzoru i tonalności.
Tile from Concept collection are characterized by a wide variety of patterns and tonalities.
Fliesen der Concept Kollektion zeichnet die Vielfalt von Mustern und Tonalitäten aus.
Плитки коллекции Concept отличаются разнообразием рисунка и оттенка.

CONCEPT



CN 13
59,7x119,7cm

R10
A



CN 13
59,7x59,7cm

R10
A



CN 13
29,7x59,7cm

R10
A

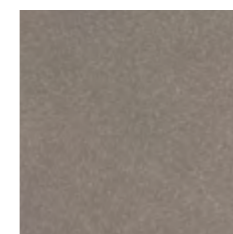

CN 13
29,7x29,7cm

R10
A

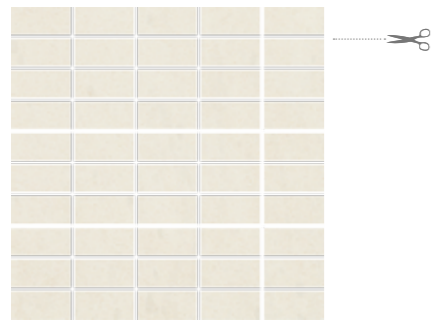

M-c-CN 99
32,7x32,7cm

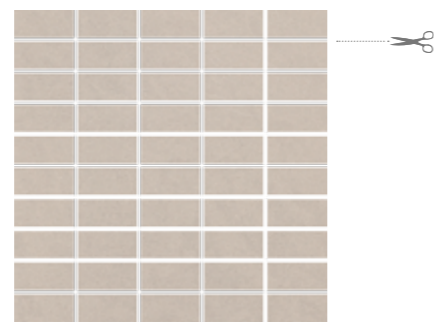

M-c-CN 12
32,7x32,7cm

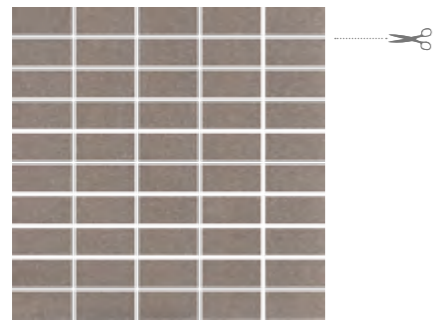

M-c-CN 13
32,7x32,7cm

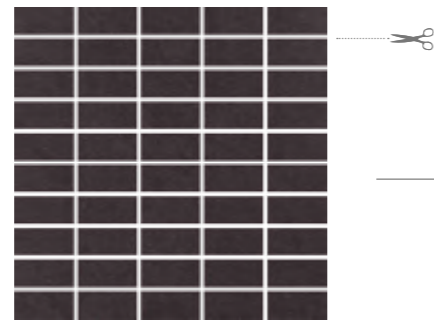

M-c-CN 14
32,7x32,7cm

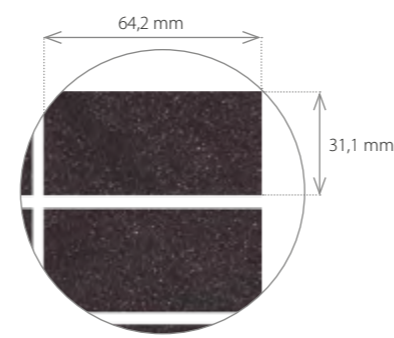

L-20P-CN 99
14,7x39,7cm



L-20P-CN 12
14,7x39,7cm



L-20P-CN 13
14,7x39,7cm

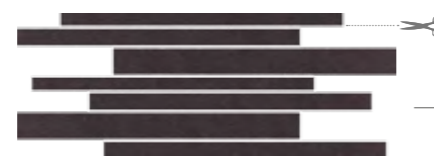

L-20P-CN 14
14,7x39,7cm

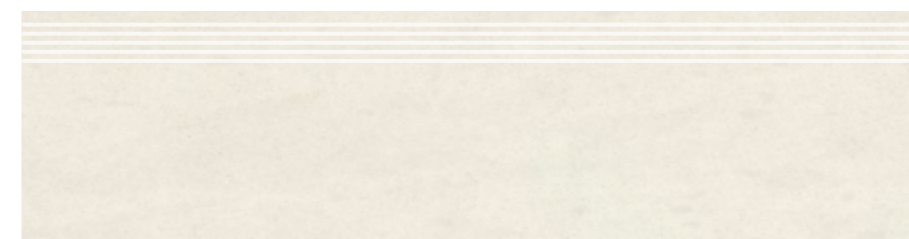

Stopnica CN 99
29,7x119,7cm

R10
A

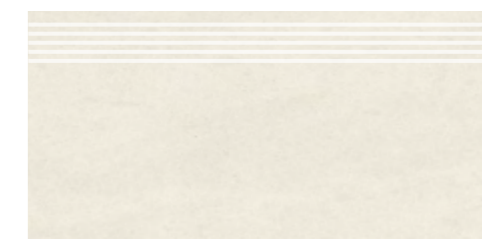

Stopnica CN 99
29,7x59,7cm

R10
A



Cokół CN 99
7,8x59,7cm



Stopnica CN 12
29,7x119,7cm

R10
A



Stopnica CN 12
29,7x59,7cm

R10
A



Cokół CN 12
7,8x59,7cm



Stopnica CN 13
29,7x119,7cm

R10
A



Stopnica CN 13
29,7x59,7cm

R10
A

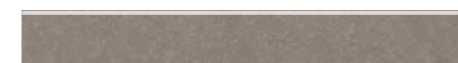

Cokół CN 13
7,8x59,7cm



Stopnica CN 14
29,7x119,7cm

R10
A













Stopnica CN 14
29,7x59,7cm

R10
A



Cokół CN 14
7,8x59,7cm

PAKOWANIE						
Płytki rektyfikowane Rectified tiles Rektifizierte Fliesen Ректифицированные плитки	29,7x29,7 cm	29,7x59,7 cm	59,7x59,7 cm	19,3x119,7 cm	29,7x119,7 cm	59,7x119,7 cm
Grubość płytek Tile thickness Fliesenstärke Толщина	0,82 cm	0,94 cm	0,94 cm	1,10 cm	1,10 cm	1,10 cm
kg/karton kg/box kg/Karton кг/коробка	22,50	30,5	30,5	23,4	36,2	36,2
szt./karton pcs/box Stck./Karton шт/коробка	13	8	4	4	4	2
m ² /karton m ² /box m ² /Karton m ² /коробка	1,17	1,44	1,44	0,96	1,44	1,44
karton/paleta box/pallet Karton/Palette коробка/поддон	44	32	30	30	15	20
m ² /paleta m ² /pallet m ² /Palette m ² /поддон	51,48	46,08	43,20	28,8	21,6	28,8
kg/paleta kg/pallet kg/Palette кг/поддон	1010	995	935	725	565	745

EBRO			
Charakterystyka techniczna płytek / Technical characteristics of tiles / Technische Charakteristik der Fliesen / Техническая характеристика плиток			
Właściwości Parameters Parameter Параметры	norma standard norm стандарт	wymagania normy requirements Normansprüche требования нормы	parametry osiągnięte achieved parameters gemessene Werte достигнутые параметры
 Nasiąkliwość wodna Water absorption Wasseraufnahme Водопоглощение	PN-EN ISO 10545 - 3	< 0,5 %	< 0,1 %
 Wytrzymałość na zginanie Bending strength Biegefestigkeit Прочность на изгиб	PN-EN ISO 10545 - 4	min. 35 N/mm ²	> 45 N/mm ²
 Siła łamiąca Breaking strength Bruchlast Предел прочности	PN-EN ISO 10545 - 4	>1300 N	-2500 N 30x60 -4200 N 60x60 120x60
 PEI	PN-EN ISO 10545 - 7	wymagane required erforderlich требуемая	5 EB01 4 EB03 EB12 EB13
 Odporność na ścieranie wgłębne* Resistance to deep abrasion* Beständigkeit gegen Tiefenverschleiß* Устойчивость к истиранию*	PN-EN ISO 10545 - 6	< 175 mm ³	-130 mm ³
 Odporność na działanie środków domowego użytku Resistance to household chemicals Beständigkeit gegen Haushaltschemikalien Устойчивость к воздействию бытовой химии	PN-EN ISO 10545 - 13	min. B	A
 Odporność na plamienie Stain resistance Fleckenbeständigkeit Устойчивость к загрязнению	PN-EN ISO 10545 - 14	min. 3	5
 Odporność chemiczna Chemical resistance Chemische Beständigkeit Химическая стойкость	PN-EN ISO 10545 - 13	Producent podaje klasyfikację The manufacturer shall provide classification Hersteller gibt die Klassifikation an Производитель приводит классификацию	LA, HA
 Odporność na pęknięcia włoskowate Capillary crack resistance Widerstandsfähigkeit gegen Glasurrisse Устойчивость к капиллярным трещинам	PN-EN ISO 10545 - 11	wymagane required erforderlich требуемая	odporne resistant bruchfest устойчивые
 Mrozoodporność Frost resistance Frostbeständigkeit Морозоустойчивость	PN-EN ISO 10545 - 12	wymagane required erforderlich требуемая	mrozoodporna frost-resistant frostbeständig морозоустойчивые
 Antypoślizgowość Anti-slippery Rutschhemmung Антискольжение	DIN 51130 DIN 51097	-	R 10 A

*Parametr dopełniający, typowy dla płytek nieszkliwionych / Complementary parameter, typical for unglazed tiles / Zusatzparameter, typisch für unglasiertes Feinsteinzeug / Дополнительный параметр, типичный для неглазурованных плиток

MIRADOR				
Charakterystyka techniczna płytek / Technical characteristics of tiles / Technische Charakteristik der Fliesen / Техническая характеристика плиток				
Właściwości Parameters Parameter Параметры	norma standard norm стандарт	wymagania normy requirements Normansprüche требования нормы	parametry osiągnięte achieved parameters gemessene Werte достигнутые параметры	
Nasiąkliwość wodna Water absorption Wasseraufnahme Водопоглощение	PN-EN ISO 10545 - 3	< 0,5 %	< 0,1 %	
Wytrzymałość na zginanie Bending strength Biegefestigkeit Прочность на изгиб	PN-EN ISO 10545 - 4	min. 35 N/mm ²	> 45 N/mm ²	
Siła łamiąca Breaking strength Bruchlast Предел прочности	PN-EN ISO 10545 - 4	>1300 N	~2500 N	30x60 60x60
PEI	PN-EN ISO 10545 - 7	wymagane required erforderlich требуемая	4	
Odporność na ścieranie Resistance to deep abrasion* Beständigkeit gegen Tiefenverschleiß* Устойчивость к истиранию*	PN-EN ISO 10545 - 6	< 175 mm ³	~130 mm ³	
Odporność na działanie środków domowego użytku Resistance to household chemicals Beständigkeit gegen Haushaltschemikalien Устойчивость к воздействию бытовой химии	PN-EN ISO 10545 - 13	min. B	A	
Odporność na plamienie Stain resistance Fleckenbeständigkeit Устойчивость к загрязнению	PN-EN ISO 10545 - 14	min. 3	4	naturalna / natural natur / натуральная
Odporność chemiczna Chemical resistance Chemische Beständigkeit Химическая стойкость	PN-EN ISO 10545 - 13	Producent podaje klasyfikację The manufacturer shall provide classification Hersteller gibt die Klassifikation an Производитель приводит классификацию	5	lappato / лаппато
Odporność na pęknięcia włoskowate Capillary crack resistance Widerstandsfähigkeit gegen Glasurrisse Устойчивость к капиллярным трещинам	PN-EN ISO 10545 - 11	wymagane required erforderlich требуемая	odporne resistant bruchfest устойчивые	
Mrozoodporność Frost resistance Frostbeständigkeit Морозоустойчивость	PN-EN ISO 10545 - 12	wymagane required erforderlich требуемая	mrozoodporna frost-resistant frostbeständig морозоустойчивые	
Antypoślizgowość Anti-slippery Rutschhemmung Антискольжение	DIN 51130 DIN 51097	-	R 11 A+B+C	naturalna / natural natur / натуральная
			R 10 A+B	lappato / лаппато

*Parametr dopełniający, typowy dla płytek nieszkliwionych / Complementary parameter, typical for unglazed tiles /
Zusatzparameter, typisch für unglasiertes Feinsteinzeug / Дополнительный параметр, типичный для неглазурованных плиток

NEUTRO / VARIO / CONCEPT				
Charakterystyka techniczna płytek / Technical characteristics of tiles / Technische Charakteristik der Fliesen / Техническая характеристика плиток				
Właściwości Parameters Eigenschaften Параметры	metoda badawcza research method Prüfverfahren метод исследования	wymagania normy requirements Normansprüche требования нормы	parametry osiągnięte achieved parameters gemessene Werte достигнутые параметры	
Nasiąkliwość wodna Water absorption Wasseraufnahme Водопоглощение	PN-EN ISO 10545 - 3	< 0,5 %	< 0,1 %	
Wytrzymałość na zginanie Bending strength Biegefestigkeit Прочность на изгиб	PN-EN ISO 10545 - 4	min. 35 N/mm ²	> 45 N/mm ²	
Siła łamiąca Breaking strength Bruchlast Предел прочности	PN-EN ISO 10545 - 4	>1300 N	~2000 N	30x30 cm
PEI	PN-EN ISO 10545 - 7	wymagane required erforderlich требуемая	~2500 N	30x60 60x60 cm
Odporność na ścieranie Resistance to deep abrasion Beständigkeit gegen Tiefenverschleiß Устойчивость к истиранию	PN-EN ISO 10545 - 6	< 175 mm ³	~4200 N	120x60 cm 120x30 cm 120x20 cm
Odporność na działanie środków domowego użytku Resistance to household chemicals Beständigkeit gegen Haushaltschemikalien Устойчивость к воздействию бытовой химии	PN-EN ISO 10545 - 13	min. UB	A*	
Odporność na plamienie Stain resistance Fleckenbeständigkeit Устойчивость к загрязнению	PN-EN ISO 10545 - 14	stosowana metoda badania applied method of analysis angewandte Prüfmethode применяемый метод испытаний	odporne (klasa 4)* resistant (class 4)* beständig (klasse 4)* устойчивые (класс 4)*	
Odporność chemiczna Chemical resistance Chemische Beständigkeit Химическая стойкость	PN-EN ISO 10545 - 13	Producent podaje klasyfikację The manufacturer shall provide classification Hersteller gibt die Klassifikation an Производитель приводит классификацию	LA*, HA*	
Mrozoodporność Frost resistance Frostbeständigkeit Морозоустойчивость	PN-EN ISO 10545 - 12	wymagane required erforderlich требуемая	mrozoodporna frost-resistant frostbeständig морозоустойчивые	
Antypoślizgowość Anti-slippery Rutschhemmung Антискольжение	DIN 51130 DIN 51097	-	R10* A*	

*Nie dotyczy powierzchni polerowanej.
Does not apply to polished surfaces.
Gilt nicht für die polierte Oberfläche.
Данные параметры не относятся к полированной поверхности.

Mrozoodporność
Frost resistance
Frostbeständigkeit
Морозоустойчивость



Gres jest mrozoodporny dzięki czemu można go stosować na zewnątrz.

Antypoślizgowość
Anti-slippery
Rutschfreiheit
Антискольжение



Płytki gresowe można używać do wykańczania miejsc narażonych na długotrwałe działanie wody – baseny, tarasy, balkony.

Odporność na ścieranie
Abrasion resistance
Abreibungfestigkeit
Устойчивость к истиранию



Gres ma wysoką odporność na zarysowania i długotrwałe ścieranie, przewyższa pod tym względem większość gatunków kamienia naturalnego.

Odporność na plamienie
Stain resistance
Fleckenbeständigkeit
Устойчивость к загрязнению



Płytki gresowe wykazują odporność na działanie kwasów, zasad oraz większości środków czyszczących domowego użytku. Jest odporna na odbarwienie pod wpływem działania promieni UV.

Niniejszy katalog jest materiałem poglądowym. Ze względu na technikę druku, rzeczywisty wygląd płytek może nieznacznie różnić się od produktów prezentowanych na zdjęciach. Ceramika Nowa Gala zastrzega sobie prawo do zmiany oferty prezentowanej w katalogu.

The present catalogue is only a visual material – so please take into consideration that because of a printing technique real appearance of tiles can be little bit different from the products presented in the pictures. Ceramika Nowa Gala reserves the right to change the offer presented in the catalogue.

Der vorliegende Katalog ist ein Anschauungsobjekt. Aufgrund der Drucktechniken können die auf den Fotos dargestellten Fliesen von deren tatsächlichem Aussehen in geringem Maße abweichen. Ceramika Nowa Gala behält sich das Gesetz vor, das im Katalog präsentierte Angebot zu ändern.

Данный каталог является наглядным материалом. Из-за техники печати действительный внешний вид плиток может незначительно отличаться от продуктов, представленных на фотографиях. Ceramika Nowa Gala имеет право на внесение изменений в ассортименте представленном в каталоге.



NowaGala
CERAMIKA

Ceramika Nowa Gala SA
ul. Ceramiczna 1
26-200 Końskie
tel.: +48 41 390 11 00
fax: +48 41 390 11 02
www.nowa-gala.com.pl